

IMPORTANT

Read this guide and follow all instructions carefully before assembling or using this product.

OWNER'S MANUAL



FAMILY FUN FOR EVERYONE

Index

Warnings.....	Pg. 3
Before You Begin.....	Pg. 4
Parts List and Specifications.....	Pg. 5
Preparing the Ground.....	Pg. 6
Pool Assembly / Liner Layout.....	Pg. 7
Pool Assembly / Frame Layout.....	Pg. 8
Pool Assembly / Completion.....	Pg. 9
Pool Assembly / Fittings	Pg. 9
Pump and Filter Assembly.....	Pg. 10
Disassembly.....	Pg. 10
Warranty.....	Pg. 11-12

Getting started:

Congratulations on the purchase of your new pool! Please read this owner's manual before beginning assembly. The information contained within this booklet will help ease the installation process and extend the life of your pool. We suggest using 2-3 people during the assembly of your pool, and don't forget to save this manual for future reference!

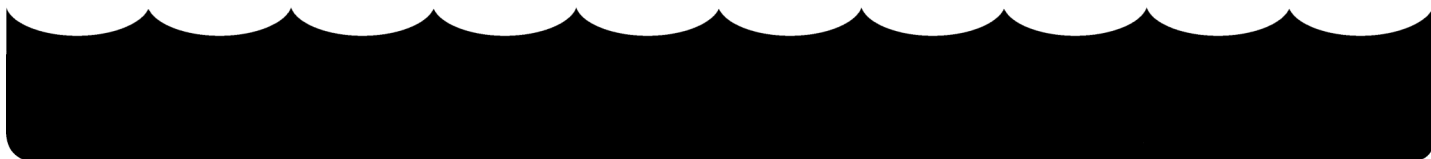

Warning

WARNING:

Never jump or dive into pool.
Horseplay of any kind in pool may result
in spinal or fatal injury.
Adult supervision is required at all times.

Important - Please Read

- Do not install your pool under electrical lines.
- Always use a GFCI outdoor protected receptacle to plug your pool equipment into.
- Always make sure that the pool area is supervised by a competent adult at all times.
- Do not allow any diving, jumping or headfirst entry into the pool.
- Never swim alone.
- Never use the pool under the influence of alcohol or drugs.
- Never allow children to use the pool unsupervised.
- Never leave your pool assembled without water.
- Never assemble the pool when the ground is off level.
- Never assemble the pool on soft or unstable ground.
- Never try to make one end deeper on the pool floor as the liner does not stretch.
- Do not over fill the pool.
- Never allow the pool to go unfiltered for a time period longer than 24 hours.
- Do not attempt assembly on any day with winds in excess of 20 MPH.
- Never assemble your pool on nut grass.
- Never assemble the pool without proper concrete or pressure treated support bases as shown in this assembly guide.
- Never drag the pool liner. Always be sure to pick up the liner and carry it.
- Always remember that safety is the key to fun in your new pool.



Before You Begin

PLEASE NOTE:

- It is normal for the pool to show some deflection of the top rails inward while the pool is filling. Once the pool has filled completely, the deflection of the top rail may be slightly outward. This is common and will not effect the structural integrity of your pool.
- In some rare cases, due to different climate conditions and local water quality, your new pool may “sweat” or “weep” slightly after being filled for the first time. This may appear around the bottom perimeter of your pool, most often noticeable when installed on cement. This “sweating” or “weeping” will most often stop once the outside air temperature and inside water temperature equalize in a few weeks time or less. This is similar to condensation which occurs on the outside of a can of cold soda on a hot day. If after several weeks, your pool continues to “sweat” or “weep”, please contact your dealer or Splash-A-Round Pools directly for further assistance.
- In some rare cases, due to the advanced design of the PVC poly-fabric reinforced heavy duty liner, small microscopic pinholes may occur in the material due to the curing process when manufactured. These microscopic pinholes may appear as a small “weep” in the material which can be easily omitted by dabbing a small amount of transparent glue which is provided with your pool. Once applied, wipe off with a dry cloth. The “weep” will immediately stop and the transparent glue will be invisible. If you do not wish to apply a small amount of transparent glue, you may simply wait a few weeks as most often the “weep” will stop on it’s own. This is in no way a defect which will affect or compromise the integrity of your new pool.
- To find the serial number of your pool, go to the side of the pool where your equipment hoses attach to the pool. On the foot strap to the right you will see your serial number SEC-#-####. The last four numbers is your serial number, and you will need this number to properly register your product within 20 days from purchase.

Parts List & Specifications

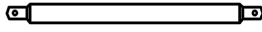
Frame Assembly List

Part	Description	Diagram	Pool Size	Qty
A	Top Rail - 48'		10 x 18	12
			14 x 22	16
			14 x 26	18
			18 x 30	22
			22 x 42	30
B	Corner Piece		10 x 18	4
			14 x 22	4
			14 x 26	4
			18 x 30	4
			22 x 42	4
C	U-Tube		10 x 18	12
			14 x 22	16
			14 x 26	18
			18 x 30	22
			22 x 42	30

Skimmer Parts

Skimmer Housing



Ladder Straps (4)

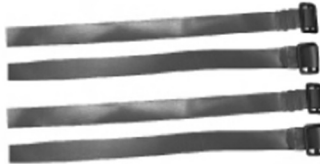

Skimmer Straps (2)



Skimmer Basket



Wall Fitting



Return



Winterizing Plugs



Vacuum Tube Adapter

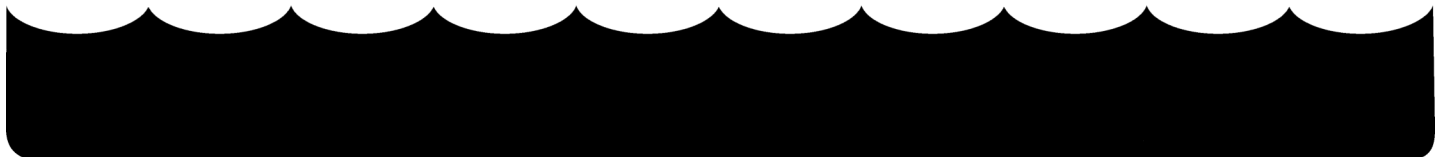

Preparing the Ground

A. Pool Size / Space Required

It is recommended to allow an additional 18" of space around the perimeter of your portable pool. For example: a 10' x 18' rectangle pool should have an area of 13' x 21'. The larger dimension (13' x 21') is referred to as the "foot print".

B. How do I find level?

It is important that your pool be placed on level ground. Though your pool can tolerate being slightly out of level, it is best for proper filtration, as well as visual concern, to have your pool as level as possible. Here is a simple way to how to find level ground:

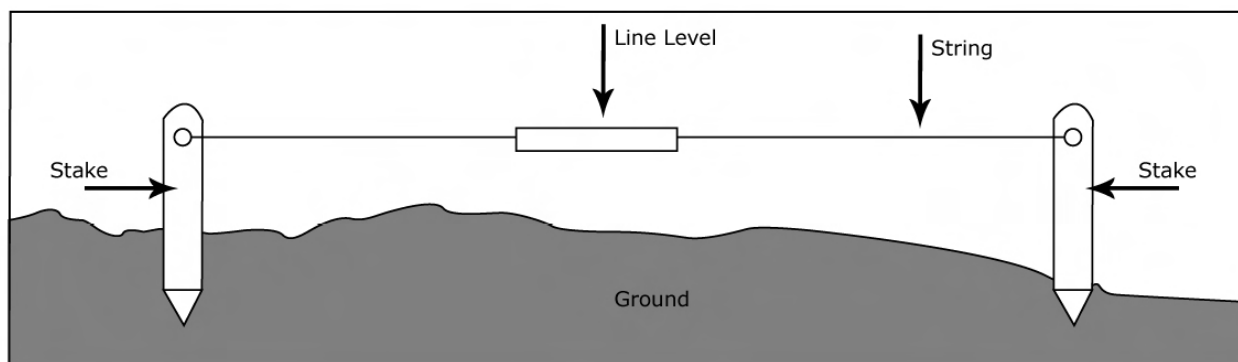

You will need:

- Two small wooden stakes
 - Length of string, two feet longer than the longest dimension of the pool
 - One "line level" (can be purchased from any hardware store)
1. Set one stake into the ground at one end of where the pool will be and the other stake at the other end.
 2. Tie the string stretched between both stakes; make sure it is stretched tight.
 3. Now set the line level in approximately the center of the string.
 4. Tap either stake further into the ground to level the string at both ends.
 5. Now measure the distance from the ground to the string at both ends. If one measurement is 5" at one stake, and 7" at the other stake, then you are only 2" off level.

C. Surface preparation:

If there is grass in the pool area, we recommend removing grass and any foliage prior to assembling of the pool. In addition to removing grass, it is recommended to add 2 to 3 inches of washed plaster sand or Happy Bottom® pad for additional protection of the pool liner prior to assembly. (Happy Bottom® can be purchased from your local swimming pool dealer).

D. Base support:

We always recommend supporting the vertical uprights with concrete or a pressure treated wood base. Failure to use support base may result in structural failure which is not covered by the warranty.

Pool Assembly / Liner Layout

Step 1:

Locate the area most suited for setting up the pool. Clear it of any sharp objects or debris and level it to zero as explained on the “Preparing the Ground” page. If the pool is assembled on unlevelled ground, it may suffer permanent structural warping or damage the liner.

Step 2:

Remove the liner from the box marked “Liner” and place it at the center of the area where you plan to assemble the pool. Take care not to damage the liner when opening the box. **DO NOT USE SHARP OBJECTS TO OPEN THE BOX THAT CONTAINS THE LINER.**

Step 3:

Unfold the liner. Locate the place where the pump and filter system will be connected and position the 2 circular openings on the side where you intend on placing the pump and filter.

Step 4:

Remove the frame (Parts A & B) from the box marked “Frame”. At this point you will not need any “U-Tubes” (Part C). Lay all of the upper frame out in the order indicated below. (Locate each frame piece corresponding with the parts list on page 5.)

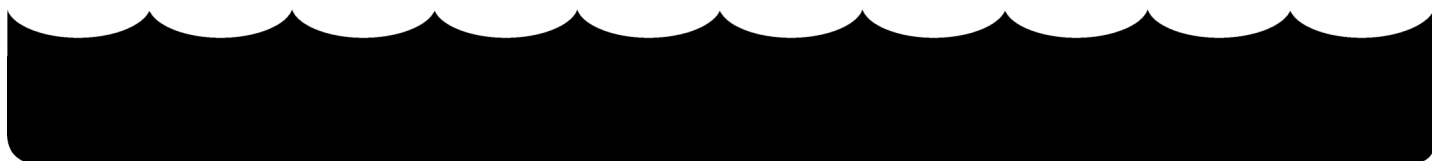
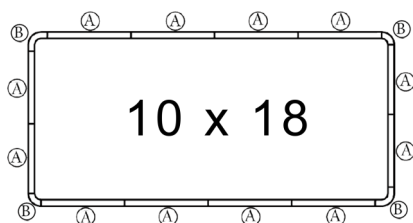

Pool Assembly / Frame Layout

Step 5

Assembling the long sides first, starting from the side at your right, **INSERT INTO THE RECTANGULAR BIG OPENING CORNER OF THE POOL, THE “A” TOP RAIL WITH THE MALE END LOOKING AHEAD.** Make sure to start from the right lateral side. This will allow the corners to fit correctly. Insert the rest of the pipes one at a time, in order of the diagram on the previous page and make sure they are locked correctly. You will hear a “click” when they are properly positioned. Make sure all holes in the pipes coincide with the openings on the sleeve of the liner. Repeat this operation with the opposite long lateral.

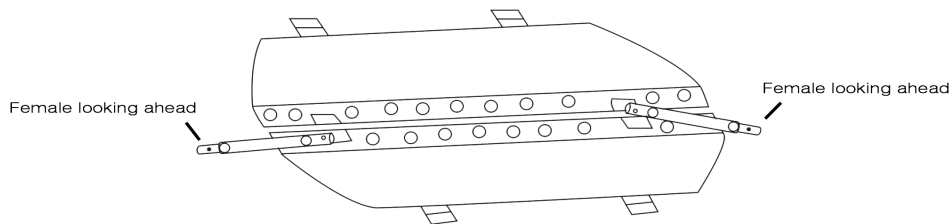

Step 6

Assembling the short sides, take a long lateral top rail and extend it outwards, (two people would be best). Repeat with the opposite long lateral top rail. As you did in Step 5, insert the top rails into the sleeve, **STARTING FROM THE RIGHT AND WITH THE FEMALE END LOOKING AHEAD.** Insert one pipe at a time in order to the diagram on the previous page making sure you hear a “click”. Repeat this operation with the opposite short lateral.

Step 7

To finish with the assembly of the top rail, insert the corner pipe with the female end into the male end of the top rail.

IMPORTANT TIP: Make sure to finish top rail assembly by inserting the last corner piece, male end last. This step is very important as the corner piece is designed with an off set. Failure to follow the instructions may result in tearing of the material. **Do no force corner piece, material will not stretch! Make sure to finish with the male end last!**

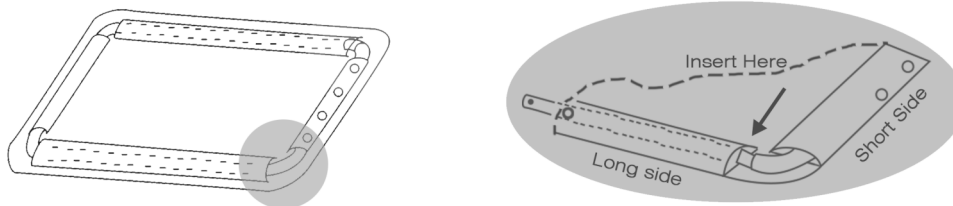

Pool Assembly / Fitting Assembly

Step 8:

Pull foot straps under liner outwards. Insert “U-Tubes” in every foot strap. Two people should lift one short lateral top rail of the pool while a third person places the top of the “U-Tube” into the corresponding holes in the underside of the top rail. The pool will remain standing, which will make it easier to fit the rest of the “U-Tubes” into the top rail.

Special note: Once you finish, make sure the liner fits comfortably on the structure. Go around the pool to check that the framework is assembled correctly. Make sure each “U-Tube” is correctly inserted into each hole on the top rail. Go around the perimeter of the pool and tug on the bottom of the “U-Tube” outward. Repeat this process 2-5 times as it will help to set the frame system and level the pool prior to filling with water. Once you start filling the pool with water, you will not be able to make any changes.

MAKE SURE EACH “U-TUBE” IS FULLY INSERTED INTO TO TOP RAIL PRIOR TO ADDING WATER.

IMPORTANT: Make sure to place a support base on concrete or treated wood under each vertical upright as correctly shown below.

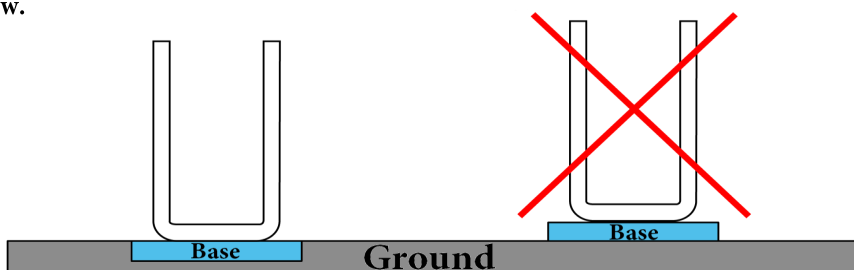

Step 9

Now that you’ve completed the pool assembly, it’s time to install the skimmer and return fitting. Follow the diagram below. Once the skimmer has been properly assembled, insert the two skimmer straps through the openings on the skimmer and buckle them securely to the loops on the pool liner.

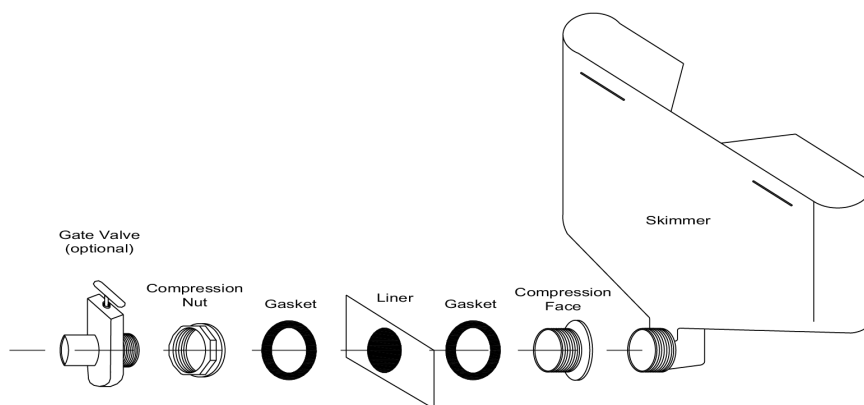

Equipment Assembly / Pool Disassembly

Step 10:

With the skimmer and return fittings now in place, assemble the pump and filter package and connect the hoses according to the diagram below. (Equipment may vary by dealer)

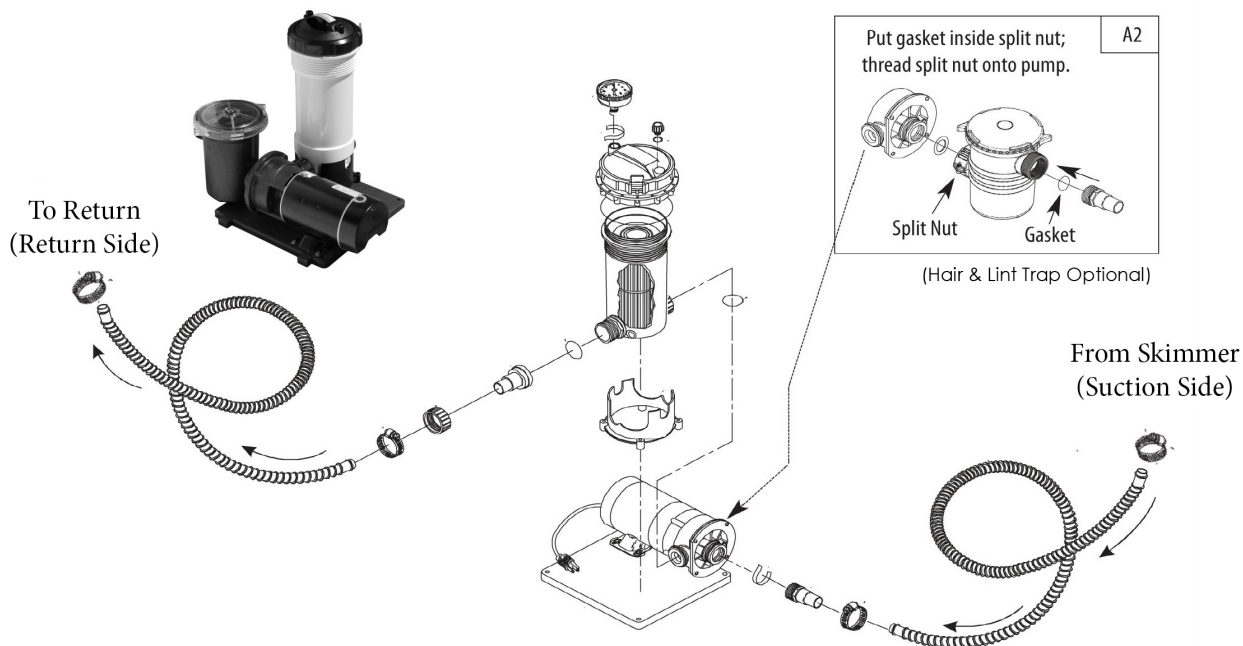

Step 11:

Before you start filling the pool with water, assemble and secure the ladder with the ladder straps included. Refer to the ladder instructions for assembly procedures.

Enjoy:

You have now completed the installation process and are ready to start enjoying the benefits of pool ownership. Be sure to retain this manual for future reference.

Disassembling the pool

Step 1

Drain the pool completely and dry all moisture off of the liner. This will prevent mildew or algae growth while in storage.

Step 2

Remove all top rails, corner pieces, "U-Tubes" and store.

Step 3

Make sure that all of your pool items are stored in a cool dry place without sun exposure.

This warranty covers the pool only supplied by Splash-A-Round Pools (SARP), which includes the metal super-structure and the polyester reinforced membrane water container structure. Excluded from this warranty are the ladders, pumps and electric motors, which are warranted by their manufacturer. To validate this limited warranty, the pools must be registered with SARP. Please provide all the information requested on the warranty registration form and mail with 20 days of purchase.



WARNING:

Never jump or dive into the pool.
Horseplay of any kind in the pool
may result in spinal or fatal injury.



Adult supervision is required at all times.

To obtain performance under this warranty, first contact the dealer from whom the product was purchased. The dealer is charged with the responsibility of determining, beyond a reasonable doubt, that the defect was once created by the manufacturer. The dealer may correct the defect or arrange to send the damaged / defective component back to SARP for repair (freight prepaid by pool owner).

SARP are designed for your swimming enjoyment. Entry and exit from your pool should only be by a proper above ground swimming pool ladder. **DO NOT DIVE OR JUMP!**

TEN YEAR LIMITED WARRANTY REGISTRATION CERTIFICATE

This card must be mailed within 20 days of your purchase

P.O.# _____ Serial # _____
Pool Size _____ Buyer (please print) _____
Dealer _____ Address _____
City _____ City _____
Your phone # _____ State _____ Zip _____
Purchaser's Signature _____ Your E-mail _____
Date purchased _____

Pool was purchased because of:

- Suggestion of dealer
- Advertising
- Your own evaluation
- Referral

Send information on the following:

- Solar / winter cover
- Pool light
- Fountains
- Automatic chlorination
- Automatic cleaners