

madimack

madimack

gt / *freedom*

INSTALLATION MANUAL



Powered by  **invermac**
TECHNOLOGY

THANK YOU

Congratulations on purchasing Madimack's innovative GT Freedom cordless robotic cleaner! We are so happy that you chose our brand to partner with. The Madimack GT Freedom represents a new era in cleaning technology, and we are thrilled that you are now a proud owner. With its cutting-edge features, intelligent navigation, and powerful performance, this robotic cleaner is set to revolutionise your cleaning routine and provide you with unmatched convenience.

We are committed to your satisfaction and are here to support you throughout your ownership journey. Should you have any questions, feedback, or require any assistance with your new Madimack GT Freedom cordless robotic cleaner, please visit our website which is just a click away www.madimack.com.

Once again, congratulations on your purchase! Enjoy getting to know one of our favourite products, the GT Freedom.
Warm regards,



Alex Welsh

Madimack Global CEO

GT FREEDOM





PLEASE READ THE MANUAL CAREFULLY BEFORE
INSTALLATION & OPERATION AND RETAIN IT FOR
FUTURE REFERENCE.



Adherence to the directions for use in this manual is extremely important for health and safety. Failure to strictly adhere to the requirements in this manual may result in personal injury, property damage and affect your ability to make a claim under Madimack's warranty provided with your product. Products must be used, installed and operated in accordance with this manual. You may not be able to claim on the manufacturer's warranty in the event that your product fault is due to failure to adhere this manual.

CONTENTS

Notice	3
Tips	5
Section 1. Product Overview	
1.1 Packaging content	6
1.2 Technical specification	7
1.3 Preparation	8
Section 2. Operation	9
2.1 Overview of Control Panel	10
2.2 Operation on the display of the unit	11
2.3 Cleaning the filter basket	12
2.4 Charging the robot	13
2.5 WIFI Matching	14
Section 3. Maintenance	17
3.1 Filter maintenance	17
3.2 Impeller maintenance	17
3.3 Replace the worn brushes	18
3.4 Replace the worn tracks	18
Section 4. Trouble Shooting	19
4.1 Troubleshooting	19
4.2 Exploded view	21
4.3 Spare parts list	22
Section 5. Warranty & Exclusions	23
FCC Caution:	25
FCC Radiation Exposure Statement	26
ISED Warning	27

WARNINGS

This page contains information that will help you operate the robot safely, prevent hazards and prevent damage to the robot or other property.

General Warnings

- Keep the robot out of reach of children or persons with reduced physical, sensory or mental capabilities without supervision or instruction
- Read the instructions before operating the robot.
- Keep the robot out of the reach of children or persons with reduced physical, sensory, or mental capabilities, or lack of experience and knowledge, unless they have been given supervision or instruction.
- The robot must be maintained by dealer except for simple routine maintenance written in this manual.
- Installers must follow manufacturer's instruction and keep in compliance with national or local standards for installation. Under no circumstances will the manufacturer be held responsible for any outcome incurred by failure to comply with applicable standards or local regulations.
- Incorrect installation or use of the robot may cause serious damage to property or injuries to people.
- Do not enter pool while the robot is in water.

Warnings On Use

- Only use the detachable supply unit provided with the robot to recharge the battery. Operate the power supply at least 3.5 meters from edge of pool
- Disconnect the robot from the power supply and insert the magnetic cap back in place before performing any maintenance on the robot
- Disconnect the robot from the supply mains before carrying out user maintenance such as cleaning the filter.
- Do not try to repair the robot yourself or open engine box in case of malfunction, please contact your dealer.
- If there is any malfunction or release of odor from the robot when charging, disconnect it from the power supply immediately and contact your dealer.
- Use only original replacement parts supplied by the manufacturer for service and repair.

General operation conditions for robotic pool cleaner

- The robot is intended to operate in pools between 0.4 and 3m depth.
The robot can operate in pool temperature between 4 and 35 degrees (below 15 degrees may effect endurance time).
- The robot will automatically stop running if the water depth is less than 40 centimeters for the purpose of motor protection.
- Do not use the robot during shock chlorination.
- Do not use the robot in thunder storm or stormy weather.
- Do not expose the robot to direct rainfall or sunlight for an extended period.
 - The robot is intended to be used with a balanced pool between PH 7.0-7.8, NaCl :5000 ppm Max, Chlorine 4 ppm Max.

CAUTIONS

- Rest/hold the robot by the pool edge for water to drain out before lifting the robot out of water, do it slowly so as to prevent back injury.
- Clean the filter basket after each cleaning cycle.
- Do not lift the robot out of water by track.



For battery protection, the robot should be fully charged every 3 months and the magnetic cap should be inserted back into the robot if it is not being used for more than 14 days.

NOTICE

- When the robot battery is below 30%, it will only clean the floor of the pool.

TIPS

How to achieve the most efficient cleaning

Place the robot at the corner of the pool for quick coverage of the entire pool floor area.

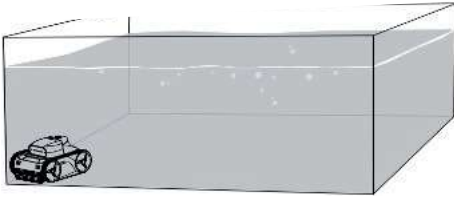

How to drain water from the robot

Place the robot on the edge of the pool for a while and let the water drain out.

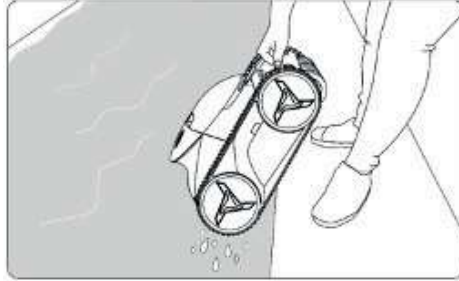

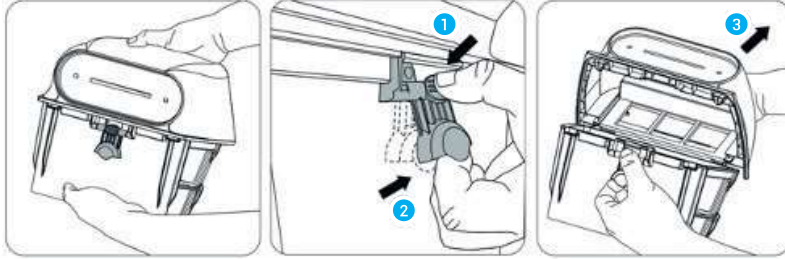

How to open the filter box

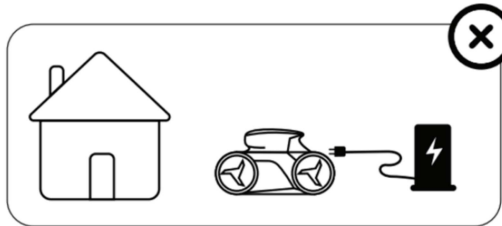

For battery protection, the robot should be fully charged every 3 months and the magnetic cap should be inserted back into the robot if it is not being used for more than 14 days.

 Do not charge the robot outdoors.



 Do not long-term expose the robot to the sun.

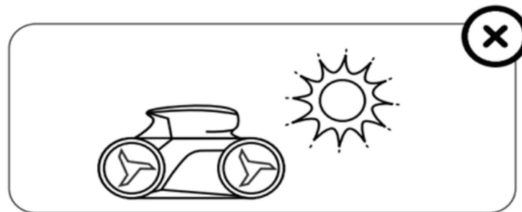

PRODUCT OVERVIEW

1.1 Packaging content

The following items are included in the packaging of robot.
Please contact your dealer if any damage or loss.

- 1 GT Freedom robot
- 2 Charger
- 3 Hook
- 4 Magnetic cap*2
- 5 User manual

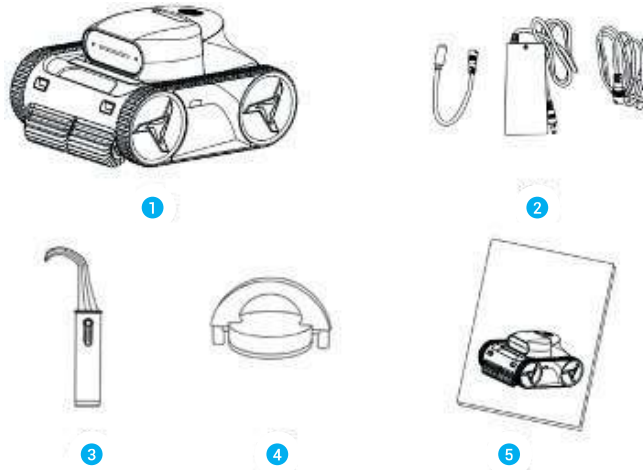

NOTE:

1. Remove the Magnetic cap 2 when using or charging. Insert Magnetic cap to machine's bottom for battery protection when not using the robot for more than 14 days.
2. If the robot fails, insert the magnetic cap into the robot for 2 seconds, remove the magnetic cap and restart the robot i.e. reset the robot.

1.2 Technical specification

Model	i30	i45	i60	i80
PERFORMANCE CONDITION: Floor mode				
Endurance time*	3h	4.5h	6h	8h
PERFORMANCE CONDITION*: Floor/wall/waterline				
Endurance time	2h	2.5h	3.5h	4.5h
Charging time	3h	4.5h	6h	8h
Battery capacity	5.2Ah (131wh)	7.8Ah (196wh)	10.4Ah (262wh)	14Ah (352wh)
Optimum pool temperature	4~35 °C			
Cleaning mode	Floor/ Floor & Wall & Waterline			
Cleaning duration options	0.5h/ 1h/ 2h/ Full Run			
Cycle setting	Repeat clean cycle - once only / every 24hr /every 48hr /every 72hr			
3D S Path with InverMac	YES			
App application	YES			
Filter capacity	3.2L			
Filtration accuracy	180µm(80mesh)			
Pump flow rate	300 - 150 (L/min)			360L - 160 (L/min)
Running power	30-110W			
Moving speed	12m/min			
Motor number	3			
Charger input	90-265VAC ~ 50/60Hz			
Running voltage/current	25.2V/1.2A			
Charger power	72.5W			
Robot NW	11.5kg	11.5kg	12kg	12kg
Robot GW Shipping	16.5kg	16.5kg	17kg	17kg
Robot dimension (L*W*H)	495*395*265 mm			
Robot packaging dimension (L*W*H)	580*448*330 mm			

*Reference: Above working time is based on 2 hours' cleaning time at floor mode in a pool.

Note: The manufacturer reserves the right to modify these specification without notice.

PRODUCT OVERVIEW

1.3 Preparation

- 1 Remove the Magnetic cap from the bottom of the robot and store it well.

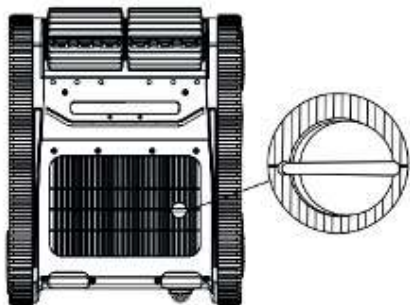

- 2 Remove the plug cover. When fully charged, cover the plug again.

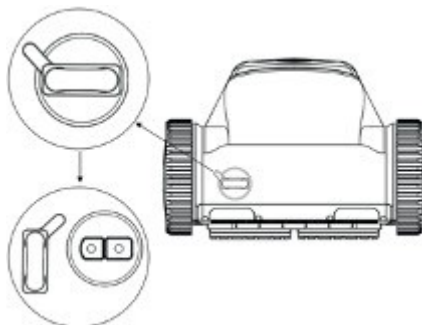

- 3 Connect to the power supply using the charger supplied. The red light indicates charging. The green light indicates power and a fully charged robot. Fully charge the robot before use.

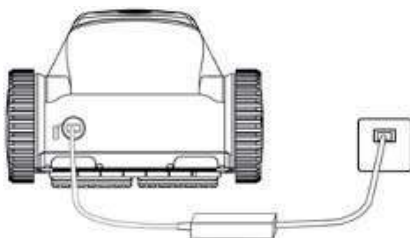

- 4 Install the configured hook on the rod (Rod is exclusive).

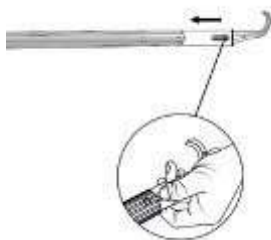

OPERATION



CAUTION

To prevent possible damages to the robot or people, be sure to follow these guidelines:

- a. After cleaning is completed, place the robot in a cool dry place away from direct sunlight.
- b. Take care when removing robot from pool and allow water to drain from robot before lifting.

IMPORTANT

- Once the robot is set up, drop into the water within 3 minutes or the robot will enter sleep mode.
- Clean the filter basket after the cleaning cycle. Avoid cleaning the surface of the filter box directly with your hands.
- The robot has a safety feature that automatically stops if a dry run happens.
- Turn the robot in all directions to release any air trapped in the robot before it enters the water. Shown below.

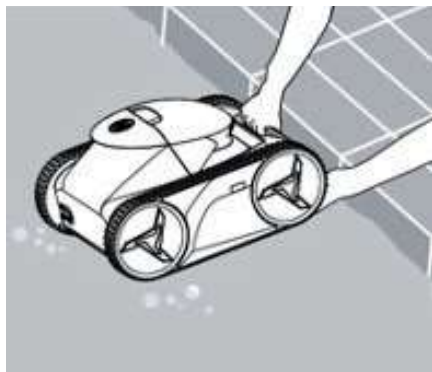

OPERATION

2.1 Overview of Control Panel

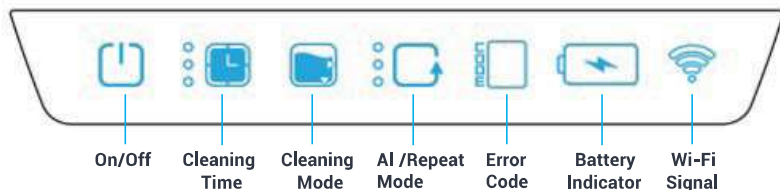



Type of button	Icon	Display Status	Description	
Power switch		Green light flashes	Setup status	
		Green light being on	Running status/Inspection status under water	
Cleaning time setup		1 green light being on	Cleaning time: 0.5H	
		2 green lights being on	Cleaning time: 1.0H	
		3 green lights being on	Cleaning time: 2.0H*	
		All lights being off	Cleaning until low battery	
Cleaning mode		Triangle green light in the floor being on	Floor cleaning mode	
		Both Triangle green lights being on	Overall cleaning mode (Floor, wall, waterline)	
AI Repeat Clean mode		1 green light being on	Cleaning every 24 hours	
		2 green lights being on	Cleaning every 48 hours	
		3 green lights being on	Cleaning every 72 hours	
		All lights off	Unit cleans once	
Error code		1	Left drive failure	
		2	Right drive failure	
		3	Abnormal water pump	
		4	Abnormal Control panel communication	
		5	Infrared sensor anomalies	
		6	Abnormal water sensor	
Battery light (Non-charging status)		1 green light being on	Battery level: 20-50%	
Low battery		2 green lights being on	Battery level: 50-75%	
		3 green lights being on	Battery level: 75-100%	
		1 red light flashes	Battery level: 15-20%	
		1 green light flashes	Battery level: 0-50%	
Battery light (Charging status)		1 green light being on, 1 green light flashes	Battery level: 50-75%	
		2 green lights being on, 1 green light flashes	Battery level: 75-100%	
		3 green lights being on	Battery level: 100%	
Signal light			Green light flashes	Network matching
			Green light on	Network matched
	Red light flashes		Failure Connection	

* Note: If the cleaning time is set to be more than 2 hours via App, there will also be 3 lights on.

OPERATION

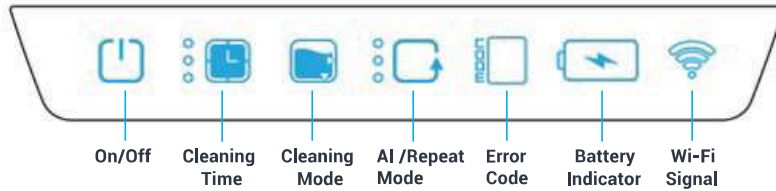

2.2 Operation on the display of the unit



- 1 Hold  for 3 seconds to activate robot. a sound will chime and the  will start to flash. Robot is now in set up mode

Set clean time,  cleaning operation  and repeat clean mode  where necessary by pressing the buttons on the control panel. See above table for more information

Once setup is complete there are two options to run the robot

1. Press  once and  will become solid light. Robot is now ready to be placed into water and will start cleaning once reached the bottom of the pool.
2. Press and hold  for 3 seconds and panel will beep once and go into standby mode. The robot will automatically start the cleaning cycle after the delayed amount of time set by the cycle mode.

For example if you set repeat every 24 hours, robot will delay for 24hours before first cleaning cycle, this is the same for 48 hours and 72 hours setting

Active Panel Tips

1. Red power light flashing - set up mode
 2. Red power light solid - run mode
 3. Panel off - standby mode
 4. Magnet fitted to base - unit off
- 2 If the battery drops to less than 15% during the cleaning cycle the robot will start to finish the cleaning cycle and move to the pool side ready for shutdown. It will enter sleep mode after 5 mins

OPERATION

2.3 Cleaning the filter Basket

When a cleaning cycle is complete, the robot will stop at the wall of the pool. Use the hook to catch the handle and lift the robot out of the water. Drain the water from the robot and clean the filter basket as shown below:

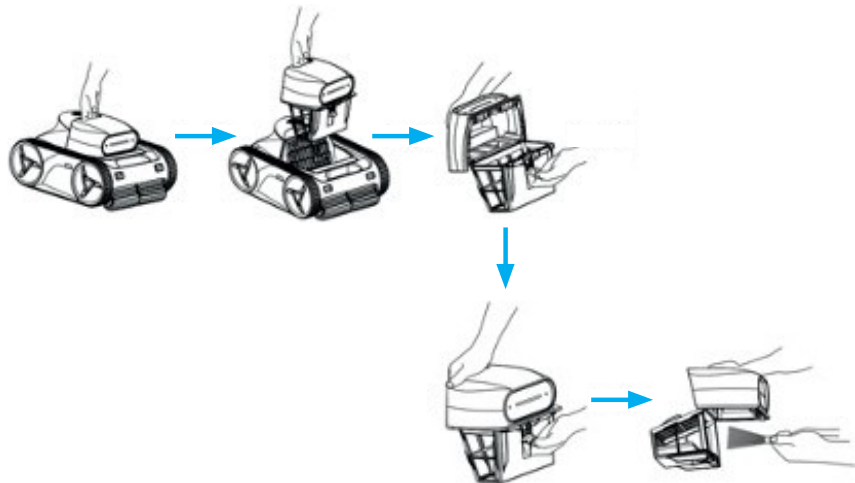

TIP! Only spray with a gentle hose, do not use high pressure or basket filter may tear, If filter does not come fully clean use a soft bristle brush to release fixed dirt

Note: To prevent injury, wear rubber gloves when cleaning the filter basket.

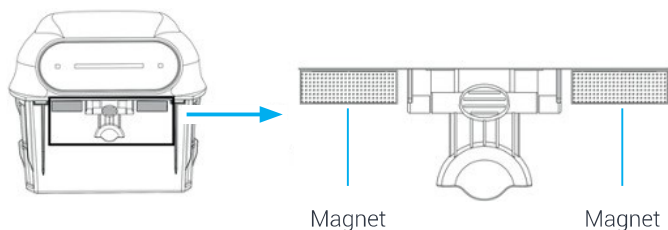

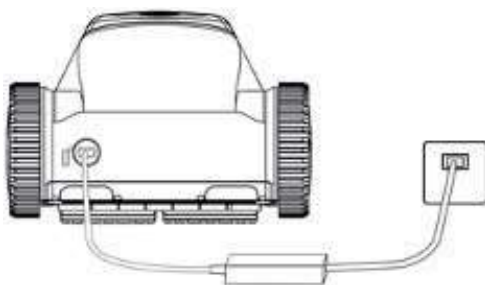
2.4 Charging the robot

- 1 Plug the adapter into power supply and make sure that indicator light is being red.
- 2 Open the cover of the robot's plug to expose the plug charging port.
- 3 Plug the adapter plug into the robot. When the robot is charging, the battery light of the robot flashes green and the indicator light on the adaptor is red.
- 4 If battery light is full with 3 green lights on, and indicator light of the power adapter goes green, then the robot is fully charged.
- 5 Before charging, make sure charging port is dry.
- 6 It is recommended to disconnect the charger after charging completed to protect the battery.
- 7 If the robot needs to be stored for a long time, it should be fully charged at least every three months to protect the battery.
- 8 It is not recommended to charge outdoors.
at least every three months to protect the battery.

Note: Use the original power adaptor with the robot ONLY.

2.5 WIFI Matching**QUICK TIPS.**

1. Place GT Freedom close to router
2. Switch bluetooth on, on phone
3. Accept pop up prompts when first starting app
4. WiFi cannot be used while robot is in water due to limitations of signals penetrating water. This includes sending and receiving notifications.

First download "Ai Bot" application from mobile app store.

Set up app ready for connecting by following on screen set up.

Once ready press to add device press and hold  for 3 seconds until robot beeps and wifi symbol starts flashing green.

Follow mobile app prompts to complete set up

After pairing mobile app

- Set clean duration in 10 minute increments.
- Set cycle schedules
- Battery indicator

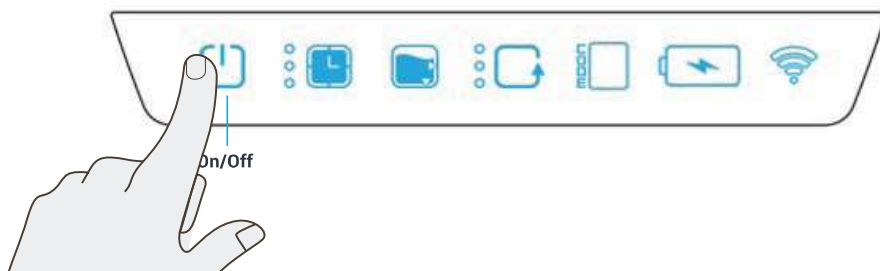
**Turn On the robot.**

OPERATION

Turn on bluetooth on your phone/tablet
Hold the floor and wall button, for 3 seconds until the robot beeps and the WIFI button starts flashing.

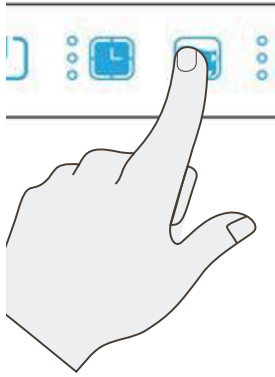

Open the AI BOT App and sign up or login

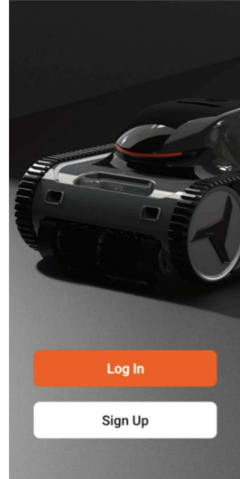

Press add device.

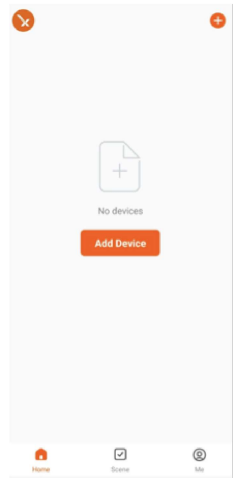

The APP will search for your robot

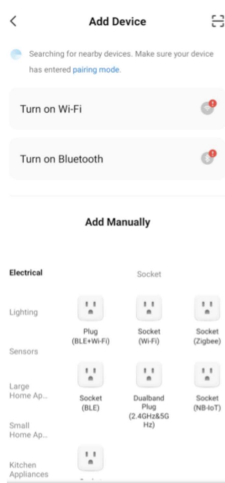

Press add in the discovering devices section
There will be a prompt to connect to WIFI if you have not already done so.
Once connected, the robot name should appear in your add device section.

Open the AI BOT App and sign up or login

OPERATION

The WIFI button will flash to indicate matching. This takes between 30 and 45 seconds. Once complete, binding completed will be displayed on your phone/ tablet screen and the WIFI button on the robot will stop flashing

You can now setup and control your robot from your tablet/phone mobile app

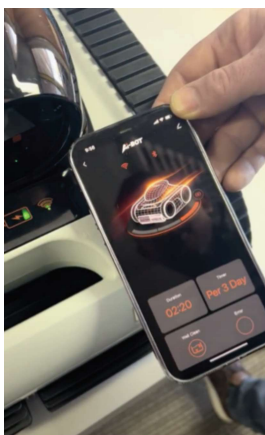



WARNING

- To avoid electric shock and other hazards which could result in major injuries, disconnect the adapter from the power source before performing any cleaning and maintenance.
- Before any maintenance and to avoid injuries caused by impeller rotation, insert the magnetic cap at the bottom of the robot.

3.1 Filter maintenance

- 1 Clean the filter thoroughly and regularly for a better cleaning and climbing performance. Otherwise, the cleaning and climbing performance may be affected when the filter is full or clogged.
- 2 Clean the clogged filter with mild acidic detergent, and it is recommended to clean it at least once a year.

3.2 Impeller maintenance

- 1 Visually check whether the impeller or impeller shaft is entangled with hair or other debris when the robot has a reduced suction or climbing performance, clean the debris trapped in the impeller.
*Magnetic **MUST** be inserted into the robot before any maintenance on the impeller.

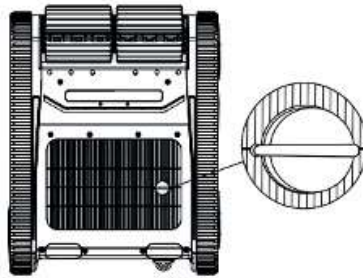

Follow the below steps

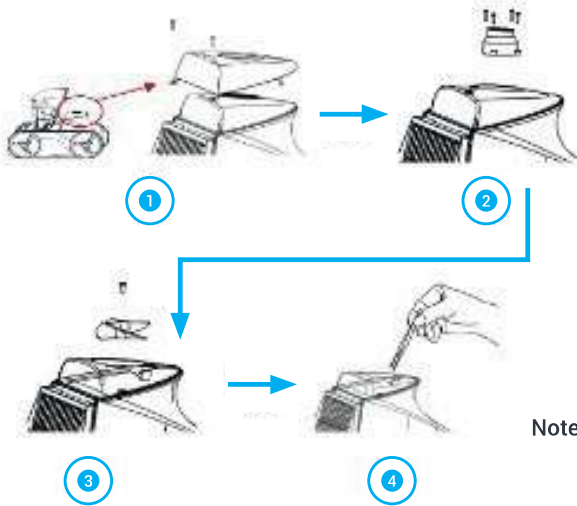

- 1 Take out the filter box, remove the fixing screws of the inflow ring cover, and take out the inflow ring cover.
- 2 Remove the deflector fixing screws and take out the deflector.
- 3 Remove the impeller screw and take out the impeller.
Note: Wear gloves when removing the impeller to prevent injury from sharp edges.
- 4 Clean the impeller debris and reassemble all the parts mentioned above in order.

Note: If you have any difficulties with impeller maintenance, contact your dealer for assistance.

MAINTENANCE

3.3 Replace the worn brushes

Remove the worn brushes & position the new brushes.

- 1 Unfasten the tabs from the holes and remove the brushes.



- 2 Fit the side without tabs under the brush holder.

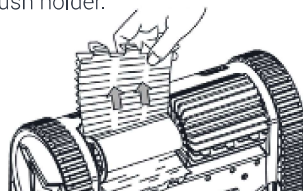

- 3 Roll the brush around its support, slide the tabs into the attachment holes and pull on the end of each tab until its edge passes through the slit.

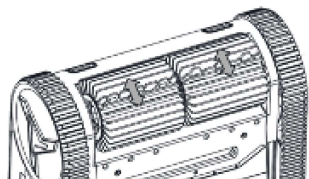

3.4 Replace the worn tracks

Remove the worn tracks.

1

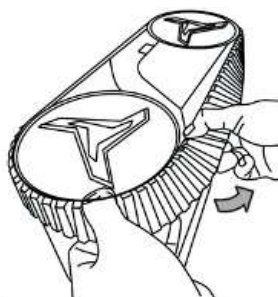

Position the new tracks:

1

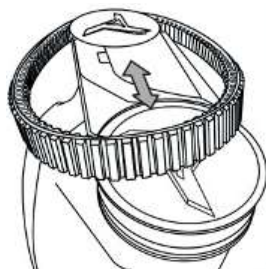

2



TROUBLE SHOOTING

4.1 Troubleshooting

Failure	Possible reason	Solution
Charging failure	Debris on the electrode of charging head (Non-failure)	Clean debris
	The bottom Magnetic cap isn't removed (Non-failure)	Remove the Magnetic cap
	Charger is damaged	Replace charger
Switch on failure	The Magnetic cap isn't removed (Non-failure)	Remove the Magnetic cap
	Water spots on the robot display or people's hand (Non-failure)	Keep the display and hands dry, then try again
	No power in the battery (Non-failure)	Get the robot fully charged
Not working (not moving, not pumping)	Low battery (Non-failure)	Get the robot fully charged
	Out of water (Non-failure)	Make sure the robot is submerged under water and indicator lights being on
	No pressing the on/off button after settings are done (Non-failure)	Press the on/off button after the settings are done, make sure indicator lights being on before putting the robot into water
	Full load of filter basket (Non-failure)	Clean filter basket
Moving but not pumping	The impeller gets stuck	Check whether there is debris in the guide ring, affecting the rotation of the impeller. (Please insert back the magnetic cap before operation, to avoid injuries caused by the impeller rotation.
	Full load of filter basket (Non-failure)	Clean filter basket
	Water inlet is blocked (Non-failure)	Take out of filter basket and clean water inlet
	Battery low (Non-failure)	Get the robot fully charged

Failure	Possible reason	Solution
Pumping but not moving	The moving motor gets stuck	Please contact the dealer for replacement
	Track is deviated and stuck (Non-failure)	Turn the robot upside down and roll the track forward and backward to restore the track
	Track is damaged	Replace track
	Scrubber gets stuck (Non-failure)	Clean scrubber
	The robot gets stuck by obstacle and shut down for auto-protection (Non-failure)	Remove obstacle and restart
	Full load of filter basket (Non-failure)	Clean filter basket
Not climbing	Under floor cleaning mode (Non-failure)	Turn to overall cleaning mode
	The impeller is stuck	Check whether there is debris in the guide ring, affecting the rotation of the impeller. (Please insert back the magnetic cap before operation, to avoid injuries caused by the impeller rotation.
	Full load of filter basket (Non-failure)	Clean filter basket
	Water inlet is blocked (Non-failure)	Take out of filter basket and clean the water inlet
Poor cleaning capability	Battery low (Non-failure)	Get the robot fully charged
	The impeller is stuck	Remove any debris or hair in the guide ring
	Full load of filter basket (Non-failure)	Clean filter basket
	Water inlet blocked (Non-failure)	Take out of filter basket and clean water inlet.
	Scrubber is damaged	Replace scrubber
	Filter basket is damaged	Replace filter basket
	Water chemistry is unbalanced	Fix water chemistry high PH in particular can cause climbing issues
Unusual non-stop	Software failure	Insert the magnetic cap back to bottom for 5s, then remove it and restart

TROUBLE SHOOTING

4.2 Exploded view

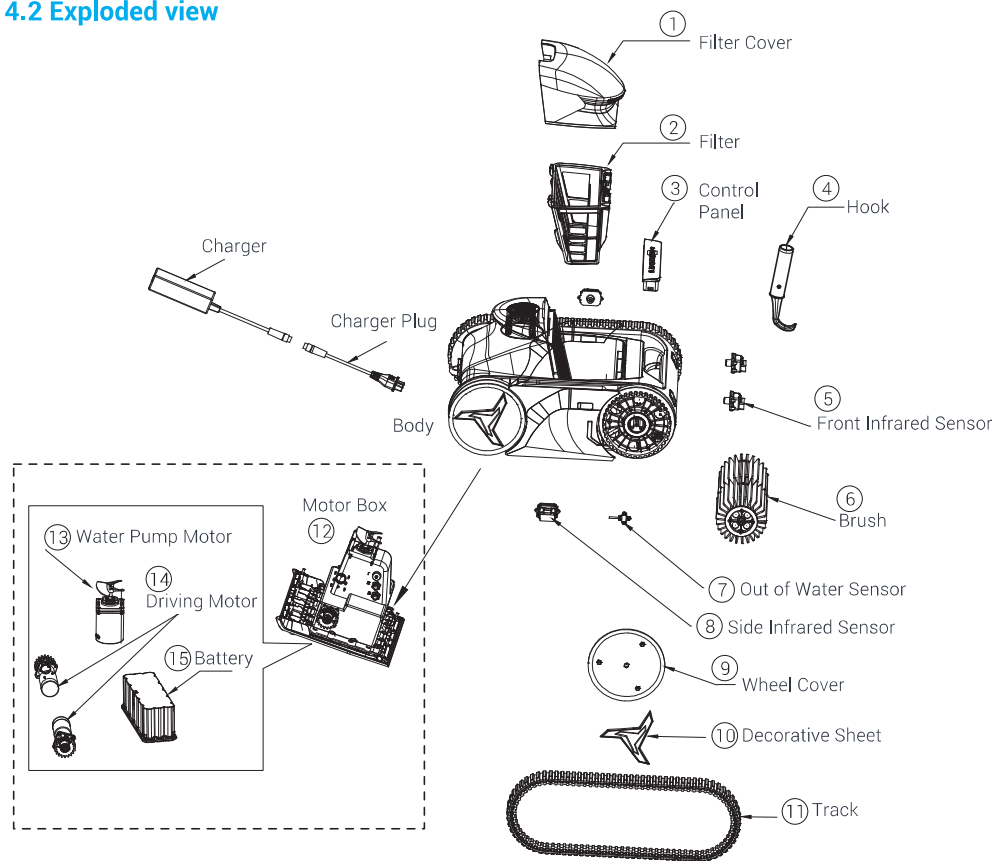
**NOTE**

- Do not use the robot when people or animals are in the pool.
 - Charger **MUST BE DISCONNECTED** before conducting any maintenance on the robot.
 - Contact your dealer for problems not covered in Trouble Shooting Guide.
 - Normally, the robot will stop at the poolside when it encounters any failure or finished it's cleaning cycle.
- If an error occurs, please restart the robot by placing the magnetic piece the underside of the robot
- If the robot is malfunctioning, an error code will appear on the operation panel (see 2.1) and the power button on the operation panel flashes red. Pressing the power button () will remove the error warning and allow operation, if error occurs again, please check troubleshooting guide

TROUBLE SHOOTING

4.3 Spare parts list

Spare parts name	Picture	Unit	Item Code	Spare parts name	Picture	Unit	Item Code
Charging Assembly		set	2020010100006	Right side cover (with screws)		set	2020010100061
Impeller (with screws)		pcs	2020010100055	Deflector ring cover (with screws)		pcs	2020010100062
Drain port cover		pcs	1223010600004	Drive wheel (with screws)		pcs	2020010100063
Guide leaf deflector (with screws)		pcs	2020010100056	Plastic bearings		pcs	1206990100003
Track belt		pcs	1223011100002	Top cover of filter cartridge		pcs	1223010400010
Rolling brush assembly (with screws)		pcs	2020010100057	Main filter cartridge assembly (with magnet)		pcs	2020010100054
Brush		pcs	1223011100001	Wrap-around filter box top cover bracket assembly (with screws)		pcs	2020010100064
Wheel cover assembly (with screws)		pcs	2020010100058	Charger port cover		pcs	1223011100003
Bearing end caps (with screws)		pcs	2020010100059	Magnetic Cap with label		pcs	2020010100052
Left side cover (with screws)		pcs	2020010100060	Hook with clip		pcs	2020010100053

**STANDARD CONDITIONS**

Madimack Pool Products Pty Ltd distributes pool products and provides the following warranties:

STATUTORY RIGHTS

The benefits to the consumer under this warranty are in addition to other rights and remedies of the consumer under the laws in relation to the goods and services to which the warranty relates.

Our goods come with guarantees that cannot be excluded under Consumer Law.

You may be entitled to a replacement or refund for a major failure and compensation for any other loss or damage. You are also entitled to have the goods repaired if the goods fail to be of acceptable quality and the failure does not amount to a major failure.

LIMITED WARRANTY

Madimack warrants that its products are free from defects in materials and manufacture for a period of 3 years from the date of purchase, unless otherwise specified.

Please visit www.madimack.com for all warranty terms and conditions

Madimack will, at its discretion, repair or replace any product proven to be defective during the warranty period for either materials or manufacture. Alternatively, Madimack will pay the cost of repair or replacement within 90 days of receiving the defective product, subject to unforeseen delays. This warranty is applicable for domestic installations only, is personal to the original purchaser, and does not transfer to any subsequent purchasers.

EXCLUSIONS

To the extent permitted by law, Madimack excludes all statutory or implied conditions and warranties, as well as any other liability that may arise under statute or at law, including without limitation liability for breach of contract, negligence, or any other cause of action. The following exclusions apply:

Incorrect operation of the unit resulting from failure to follow the provided instructions.

Damage caused to the robot due to misuse or any means other than a manufacturer defect.

Repairs or servicing performed by unauthorized dealers or service stations.

Damage caused by an unauthorized service station that compromises the battery seal.

Overcharging the battery by using a non-specified input power adapter.

Faults in the machine's operation caused by the use of non-specified accessories.

General wear and tear of consumable products, including filters, tracks, and brushes.

LIMITATION OF LIABILITY

To the extent permitted by law, Madimack's liability under any condition or warranty that cannot be legally excluded in relation to the supply of goods and services is limited to one of the following options:

Repairing the goods.

Replacing the goods with equivalent products or services.

Paying the cost of replacing the goods or providing equivalent products or services again.

Paying the costs of repairing the goods.

PROCEDURE FOR WARRANTY CLAIMS

In the event of a warranty claim, the faulty product must be returned to the place of purchase or, if installed by an approved agent, to an authorized warranty agent. Madimack does not accept returns directly from end consumers.

You are responsible for arranging the removal of the defective product and the installation of the repaired or replacement product. This includes all transportation costs and any applicable insurance fees associated with transporting the products to the supplier and the replaced or repaired product from the supplier.

All returns require Madimack's written approval and must be accompanied by either:

A Field Inspection Report authorized by the Local Customer Service Manager or Authorized Agent, or
A "Return Goods Authorization"



INDOOR

For switch power supply indoor use only.



Recycling

When disposing of the product, please hand it over to a designated collection point for the recycling of waste electrical and electronic equipment. The separate collection and recycling of waste equipment at the time of disposal will help ensure that it is recycled in a manner that protects human health and the environment. For more information about where you can drop off your waste for recycling, please contact your local authority

FCC Caution:

Changes or modifications to this unit not expressly approved by the party responsible for compliance could void the user's authority to operate the equipment.

This device complies with part 15 of the FCC Rules. Operation is subject to the following two conditions:

(1) This device may not cause harmful interference, and (2) this device must accept any interference received, including interference that may cause undesired operation.

IMPORTANT NOTE:**Note:**

This equipment has been tested and found to comply with the limits for a Class B digital device, pursuant to part 15 of the FCC Rules. These limits are designed to provide reasonable protection against harmful interference in a residential installation. This equipment generates, uses and can radiate radio frequency energy and, if not installed and used in accordance with the instructions, may cause harmful interference to radio communications. However, there is no guarantee that interference will not occur in a particular installation. If this equipment does cause harmful interference to radio or television reception, which can be determined by turning the equipment off and on, the user is encouraged to try to correct the interference by one or more of the following measures:

- Reorient or relocate the receiving antenna.
- Increase the separation between the equipment and receiver.
- Connect the equipment into an outlet on a circuit different from that to which the receiver is connected.
- Consult the dealer or an experienced radio/TV technician for help

FCC Radiation Exposure Statement:

This equipment complies with FCC radiation exposure limits set forth for an uncontrolled environment. This equipment should be installed and operated with a minimum distance of 20inches between the radiator & your body. This transmitter must not be co-located or operating in conjunction with any other antenna or transmitter CAN ICES-003 (B)/NMB-003(B)

ISED Warning

This device contains licence-exempt transmitter(s)/receiver(s) that comply with Innovation, Science and Economic Development Canada's licence-exempt RSS(s). Operation is subject to the following two conditions:

- (1) This device may not cause interference.
- (2) This device must accept any interference, including interference that may cause undesired operation of the device.

This equipment complies with FCC's and IC's RF radiation exposure limits set forth For an uncontrolled environment. The antenna(s) used for this transmitter must be installed and operated to provide a separation distance of at least 20 inches from all persons and must not be collocated or operating in conjunction with any other antenna or transmitter. Installers must ensure that 20 inches separation distance will be maintained between the device (excluding its handset) and users.

Changes or modifications to this unit not expressly approved by the party responsible for compliance could void the user's authority to operate the equipment.



This guide may be updated without notice.

Visit the official Madimack website for the latest version: <https://www.madimack.com>

GT FREEDOM